

**NOTES:**

1. Material : Spring Steel
2. Finish : Glod Irridite
3. Ends : Closed
4. Total Coils : 11.000
5. Sugg. Max. Deflection : 0.170 (in)
6. Sugg. Max. Load : 13.000 (lbs)
7. All Drawing Dimensions are in Inches [mm]

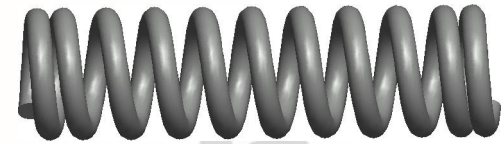

$\varnothing$  0.045  
 [1,14]  
 WIRE DIA

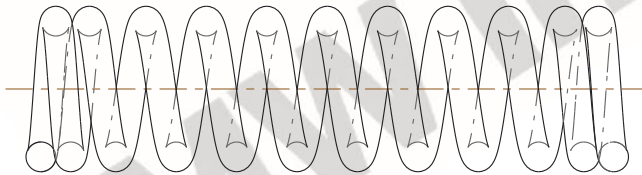

1.910  
 [48,51]  
 LENGTH

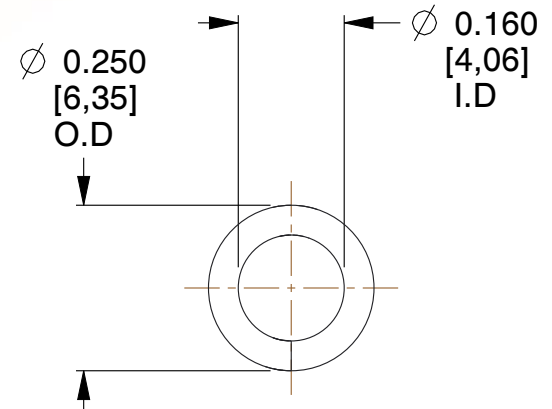

$\varnothing$  0.250  
 [6,35]  
 O.D

$\varnothing$  0.160  
 [4,06]  
 I.D

COMPONENT		SPRINGS	
<b>11899</b>  COMPRESSION SPRINGS		UNIT	INCH [mm]
		SHEET	1 of 1