

NOTES:

1. Material : Stainless Steel
2. Finish : Glod Irridite
3. Ends : Closed and Ground
4. Total Coils : 6.000
5. Sugg. Max. Deflection : 0.760 (in)
6. Sugg. Max. Load : 9.700 (lbs)
7. All Drawing Dimensions are in Inches [mm]

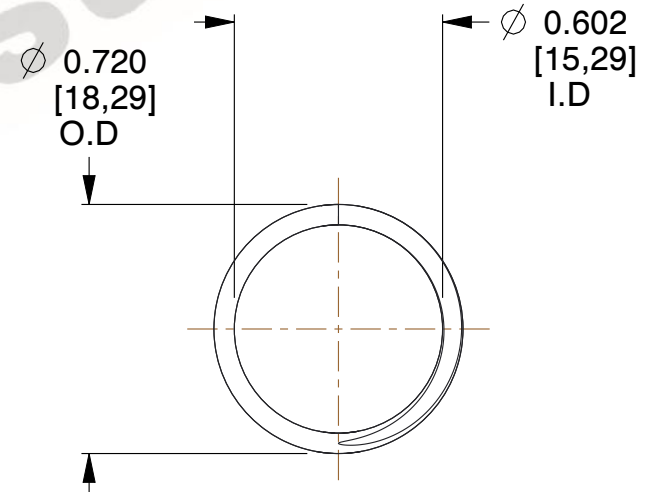
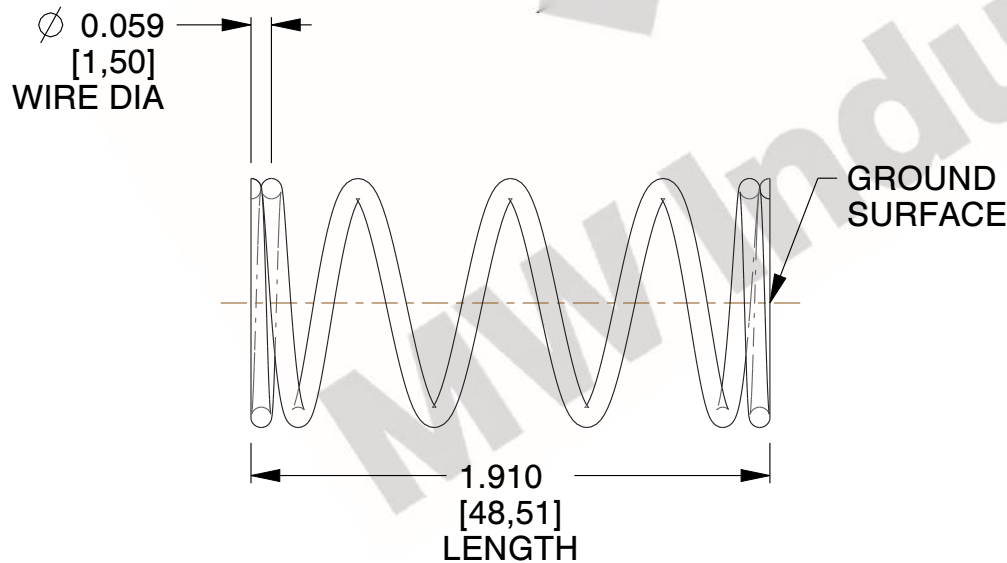
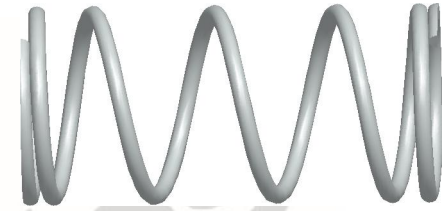

COMPONENT		SPRINGS	
71942S COMPRESSION SPRINGS		UNIT	INCH [mm]
		SHEET	1 of 1