

**NOTES:**

1. Material : Stainless Steel
2. Finish : Glod Irridite
3. Ends : Closed and Ground
4. Total Coils : 13.800
5. Sugg. Max. Deflection : 1.200 (in)
6. Sugg. Max. Load : 17.000 (lbs)
7. All Drawing Dimensions are in Inches [mm]

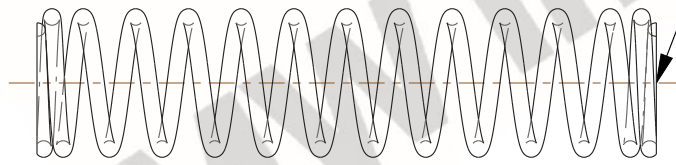

$\varnothing$  0.067  
 [1,70]  
 WIRE DIA



GROUND SURFACE

1.910  
 [48,51]  
 LENGTH

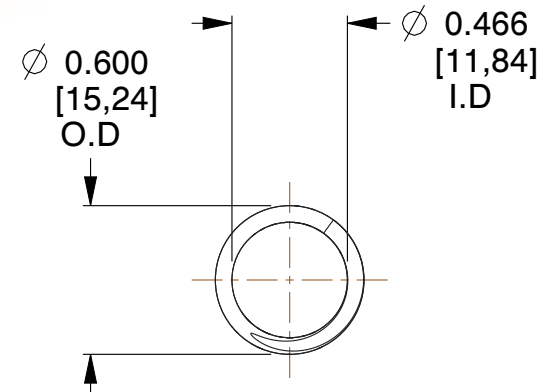

$\varnothing$  0.600  
 [15,24]  
 O.D

$\varnothing$  0.466  
 [11,84]  
 I.D

COMPONENT		SPRINGS	
<b>71788S</b>  COMPRESSION SPRINGS		UNIT	INCH [mm]
		SHEET	1 of 1