

NOTES:

1. Material : Music Wire
2. Finish : Zinc - Z
3. Ends : Closed
4. Total Coils : 15.000
5. Sugg. Max. Deflection : 0.710 (in)
6. Sugg. Max. Load : 0.780 (lbs)
7. All Drawing Dimensions are in Inches [mm]

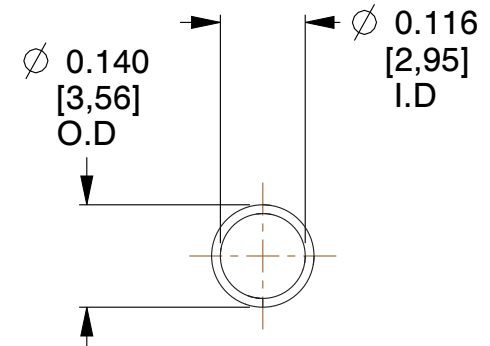
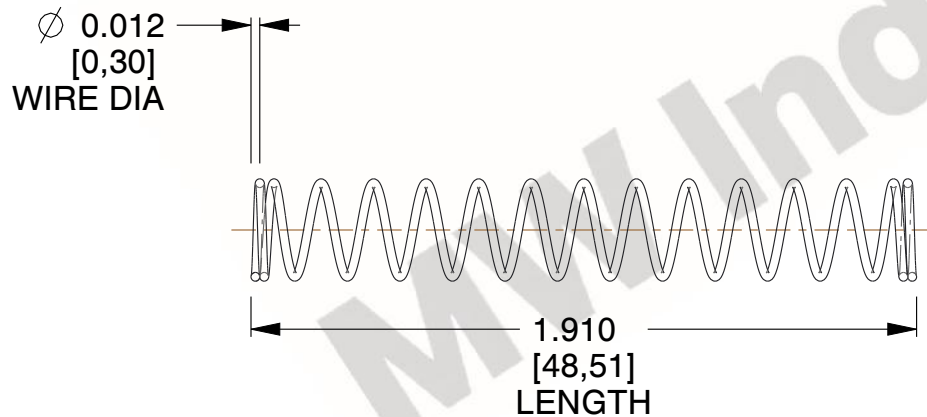

COMPONENT		SPRINGS	
1831 COMPRESSION SPRINGS		UNIT	INCH [mm]
		SHEET	1 of 1