

**NOTES:**

1. Material : Stainless Steel
2. Finish : Glod Irridite
3. Ends : Closed and Ground
4. Total Coils : 10.300
5. Sugg. Max. Deflection : 1.900 (in)
6. Sugg. Max. Load : 20.000 (lbs)
7. All Drawing Dimensions are in Inches [mm]

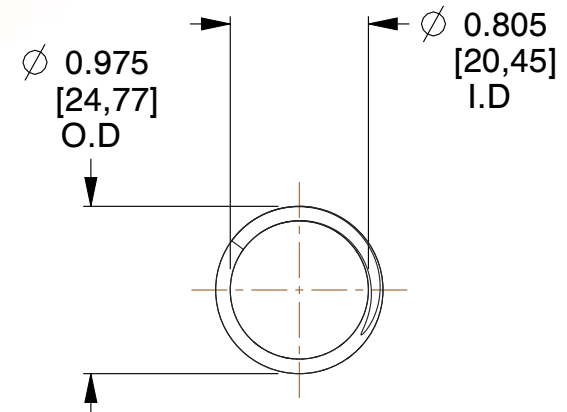
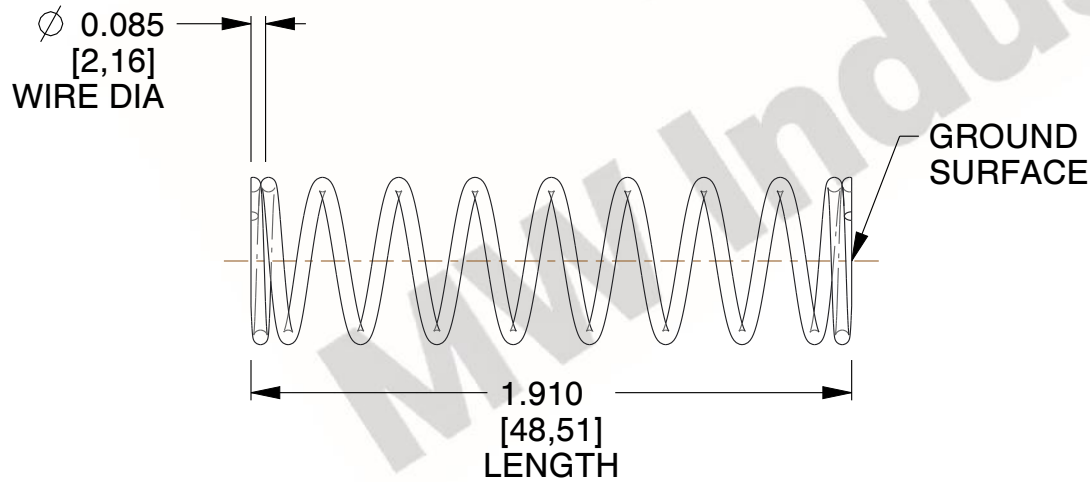

COMPONENT		SPRINGS	
72392S		UNIT	
		INCH [mm]	
		SHEET	
COMPRESSION SPRINGS		1 of 1	