

NOTES:

1. Material : Music Wire
2. Finish : Glod Irridite
3. Ends : Closed and Ground
4. Total Coils : 5.250
5. Sugg. Max. Deflection : 0.320 (in)
6. Sugg. Max. Load : 13.000 (lbs)
7. All Drawing Dimensions are in Inches [mm]

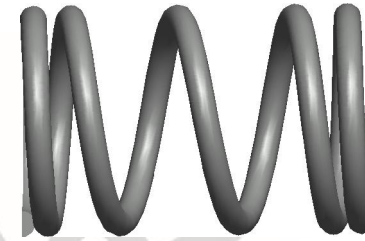

∅ 0.047
[1,19]
WIRE DIA

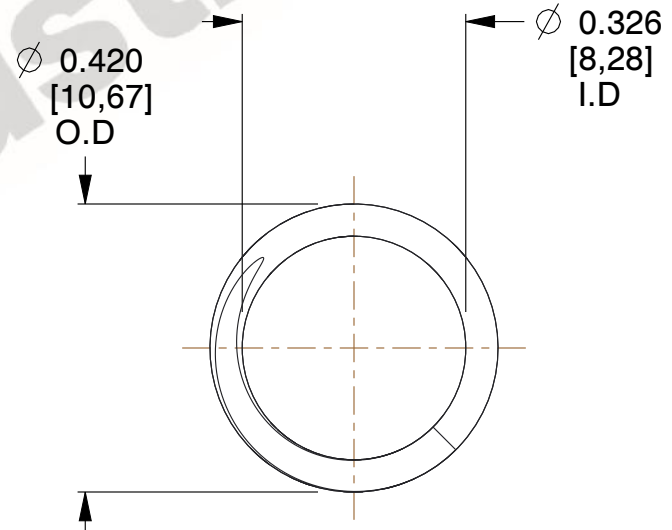
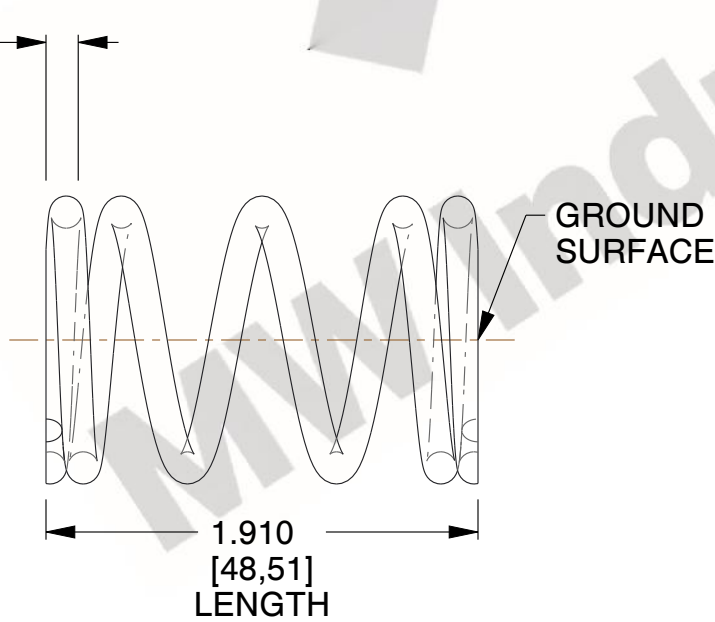

COMPONENT		SPRINGS	
71363		UNIT	
		INCH [mm]	
		SHEET	
COMPRESSION SPRINGS		1 of 1	