

**NOTES:**

1. Material : Stainless Steel
2. Finish : Glod Irridite
3. Ends : Closed and Ground
4. Total Coils : 11.100
5. Sugg. Max. Deflection : 1.200 (in)
6. Sugg. Max. Load : 9.400 (lbs)
7. All Drawing Dimensions are in Inches [mm]

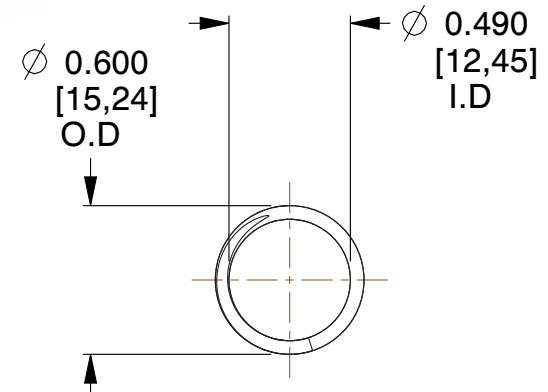

∅ 0.055  
[1,40]  
WIRE DIA

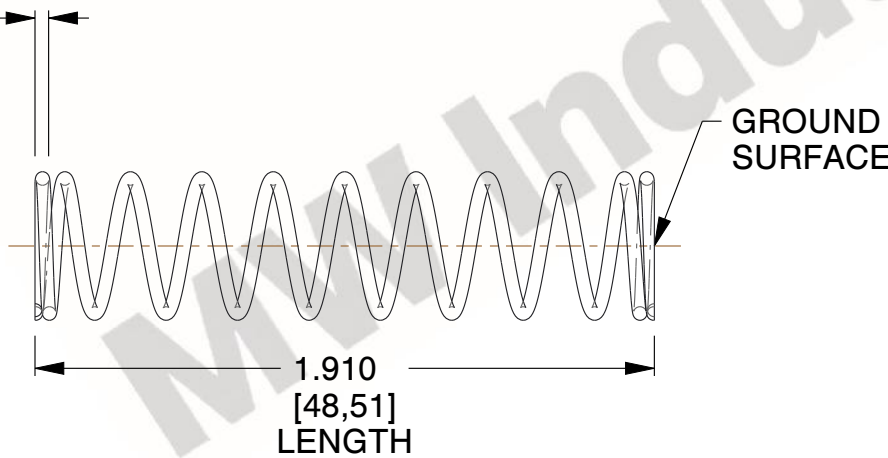

COMPONENT		SPRINGS	
<b>71750S</b>		UNIT	
		INCH [mm]	
		SHEET	
COMPRESSION SPRINGS		1 of 1	