

NOTES:

1. Material : Stainless Steel
2. Finish : Glod Irridite
3. Ends : Closed and Ground
4. Total Coils : 11.000
5. Sugg. Max. Deflection : 0.820 (in)
6. Sugg. Max. Load : 6.400 (lbs)
7. All Drawing Dimensions are in Inches [mm]

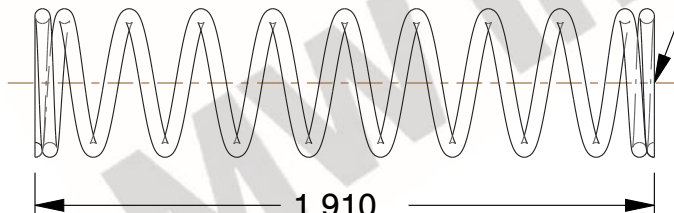

\varnothing 0.042
 [1,07]
 WIRE DIA



1.910
 [48,51]
 LENGTH

GROUND SURFACE

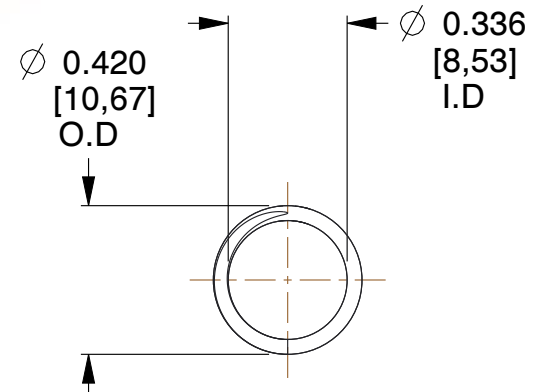

\varnothing 0.420
 [10,67]
 O.D

\varnothing 0.336
 [8,53]
 I.D

COMPONENT		SPRINGS	
71347S COMPRESSION SPRINGS		UNIT	INCH [mm]
		SHEET	1 of 1