

NOTES:

1. Material : Stainless Steel
2. Finish : Glod Irridite
3. Ends : Closed and Ground
4. Total Coils : 13.300
5. Sugg. Max. Deflection : 0.920 (in)
6. Sugg. Max. Load : 7.800 (lbs)
7. All Drawing Dimensions are in Inches [mm]

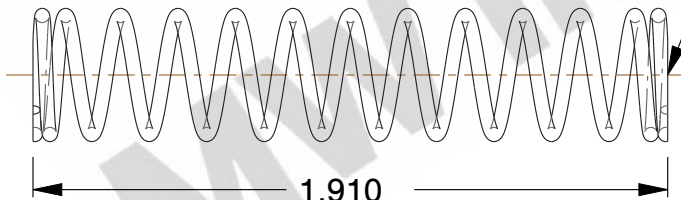

\varnothing 0.045
 [1,14]
 WIRE DIA



1.910
 [48,51]
 LENGTH

GROUND SURFACE

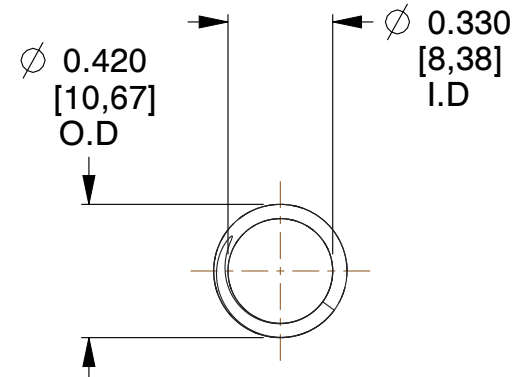

\varnothing 0.420
 [10,67]
 O.D

\varnothing 0.330
 [8,38]
 I.D

COMPONENT		SPRINGS	
71359S COMPRESSION SPRINGS		UNIT	INCH [mm]
		SHEET	1 of 1