

NOTES:

1. Material : Stainless Steel
2. Finish : Glod Irridite
3. Ends : Closed and Ground
4. Total Coils : 14.800
5. Sugg. Max. Deflection : 1.300 (in)
6. Sugg. Max. Load : 17.000 (lbs)
7. All Drawing Dimensions are in Inches [mm]

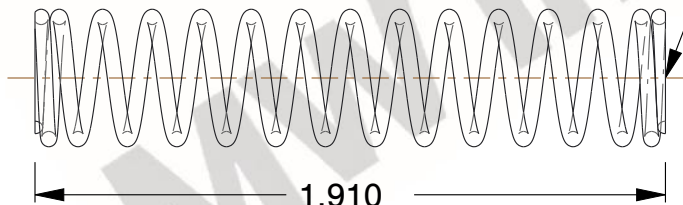

\varnothing 0.067
 [1,70]
 WIRE DIA



1.910
 [48,51]
 LENGTH

GROUND SURFACE

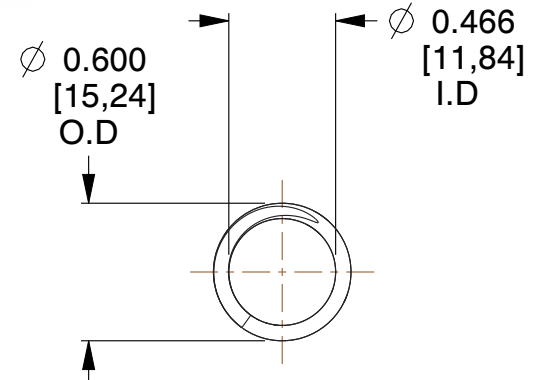

\varnothing 0.600
 [15,24]
 O.D

\varnothing 0.466
 [11,84]
 I.D

COMPONENT		SPRINGS	
71789S COMPRESSION SPRINGS		UNIT	INCH [mm]
		SHEET	1 of 1